

EZTouch mini.PLC[®] Specification Sheet

EZTouch.mini.PLC Model Specifications		
Model	3.5" EZTouchminiPLC	6" EZTouchminiPLC
Part Number	EZ-T4C-MINIPLC EZ-T4C-MINIPLC-E	EZ-T6C-MINIPLC EZ-T6C-MINIPLC-E
Total I/Os	Fixed I/O PLC, 12 DC Inputs (250 KHz Quadrature Encoder input configurable), 8 DC Sourcing Outputs, 4 Relay Outputs, 2 Analog In (0-10V), 1 Analog Out (0-10V)	
Digital Inputs	4 configurable Sinking or Sourcing <u>electrically isolated</u> inputs, 8 Sourcing inputs (3 inputs configurable for a Counter Quadrature input with A, B, and RST signals up to 250 KHz)	
Digital Outputs	8 Sourcing Outputs (50 V, 500mA per output, Short Circuit Proof with Fly Back Diodes and Overload Protection)	
Relay Outputs	4 Relay Outputs (1 Form C Relays rated at 5 Amps each with RC Snubber Protection)	
Analog I/Os	2 Analog In (0-10V), 1 Analog Out (0-10V) - 12 bit Resolution (0 to 4095)	
Display Type	3.5" TFT / 5.7" TFT (128 Color Palette)	
Brightness/Life	400 nits / 75,000 hours@55 °C (White LED)	
Screen Resolution	320 x 240	
Touch Screen	48 Resistive Touch Cell (8x6)	
Num of Display Screens	Up to 999 Limited by display memory	
Display Screen Saver	Yes, Backlight Off	
Maximum Power Consumption	Backlight ON: 12 Watts @ 24VDC, All I/O ON max power 30 Watts	
PLC Features	Full Featured with Free-Flow Ladder Logic, Function Blocks, Advanced Math and Auto-Tuned PID control	
# of PLC Registers	Non-volatile registers/Bits: 8192 16Bit, Registers: 256, S-bits: 128	
PLC Typical Scan Time	5ms	
Real Time Clock/Cal.	Built-In, Lithium coin cell battery with 5 year life expectancy, with a low battery indicator	
PLC LED Indicators	Input Power, CPU Status	
Electrical Noise	Nema ICS 2-230 Showering arc; ANSI C37.90a SWC; Level C Chattering Relay Test	
Withstand Voltage	1000VDC (1 minute) between power supply input terminal and protective ground)	
Insulation Resistance	Over 20M Ohm between power supply input and terminal and protective ground	
Enclosure	Nema 4, 4x (indoor)	
Operating Temperature	0 to 55°C (32 to 131°F)	
Storage Temperature	-20 to 60°C (-4 to 140°F)	
Vibration	5 to 55Hz 2G's for 2 hours in X,Y,and Z axis	
Shock	10G for under 12ms in the X,Y, and Z axis	
Humidity	10-95% RH, Non-Condensing	
Communication Ports	Built-in 9-pin D Sub (female) RS232/485/422 and Ethernet Ports (optional model)	
Agency Approval	UL, CUL, CE	
External Dimensions	5.06" x 4.08" x 1.783" (129 x 104 x 45.3mm)	8.050" x 6.150" x 2.8" (204.47 x 156.21 x 71.12 mm)
Weight	2 lbs	

EZTouch mini.PLC® 6" TFT Color

6" Color EZTouch.mini.PLC (5.7" TFT) Overview

EZTouchminiPLC is an engineering marvel with a 5.7" TFT Color HMI Touchscreen + Full Blown PLC + 27 I/O points great for all types of control applications.

The EZTouchminiPLC offers advanced HMI functions including great graphics, animation, data logging, alarm management, Advanced PLC ladder instructions and function blocks.



Features:

HMI:

- 5.7" TFT Color Touchscreens
- Built-in Image Library (4000+ Symbols)
- Advanced Alarm Messages & Screens
- Email & Text Message Alerts
- Trending Graphs
- Data logging
- Up to 999 User designed screens
- Patented Online Edit of HMI (No Machine Downtime, Edit on the Fly)
- Ethernet Port for Remote Access and connectivity to PLCs, AC Drives, or 3rd party devices
- Dual Driver Support to simultaneously interface with Major Brand PLCs or AC Drives (Allen Bradley, ABB, Omron, Siemens, Mitsubishi, Automation Direct etc.)

PLC:

- Total I/O: 27 points. 12 DC Inputs (250 KHz Quadrature Encoder input configurable), 8 DC Sourcing Outputs, 4 Relay Outputs, 2 Analog In (0-10V), 1 Analog Out (0-10V)
- Auto-tuned PID,
- Advanced Math Function Blocks
- Recipe Editing
- Date, Time and Event Based Control
- Advanced Ladder Logic Instruction Set
- Quadrature Input for High Speed Counter up to 250 KHz

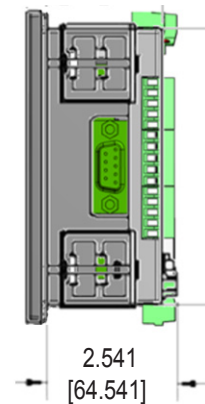
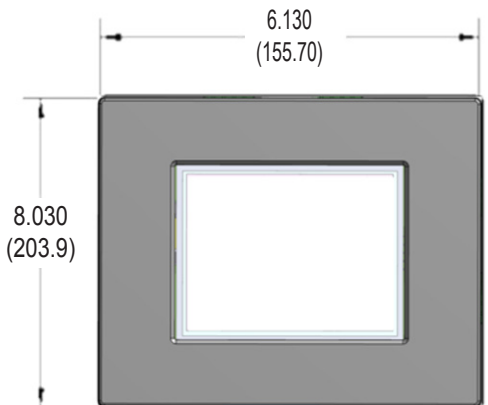

Part Number	Description	Price
EZ-T6C-MINIPLC	5.7" TFT Color, 12 DC Inputs, 8 DC Sourcing Outputs, 4 Relay Outputs (5 Amp each), 2 Analog In (0-10V), 1 Analog Out (0-10V)	See Web
EZ-T6C-MINIPLC-E	5.7" TFT Color, 12 DC Inputs, 8 DC Sourcing Outputs, 4 Relay Outputs (5 Amp each), 2 Analog In (0-10V), 1 Analog Out (0-10V) with Ethernet	

6" EZTouch.mini.PLC Status Indicators and Connections

EZ to Wire Phoenix Plug-in Terminals

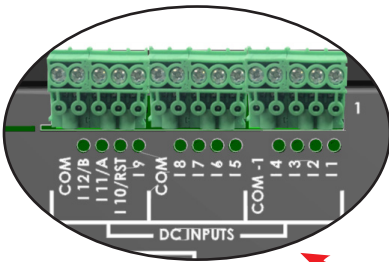

12 Digital Inputs, including a high speed quadrature counter input with LED indicators

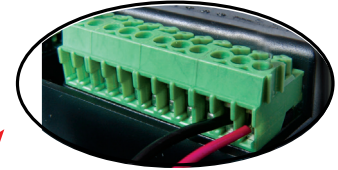

1.14 AWG, 2 18 AWG, 4 22 AWG wires per terminal

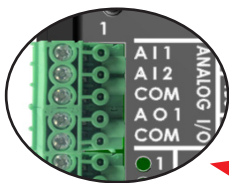

2 Analog Inputs & 1 Analog Output

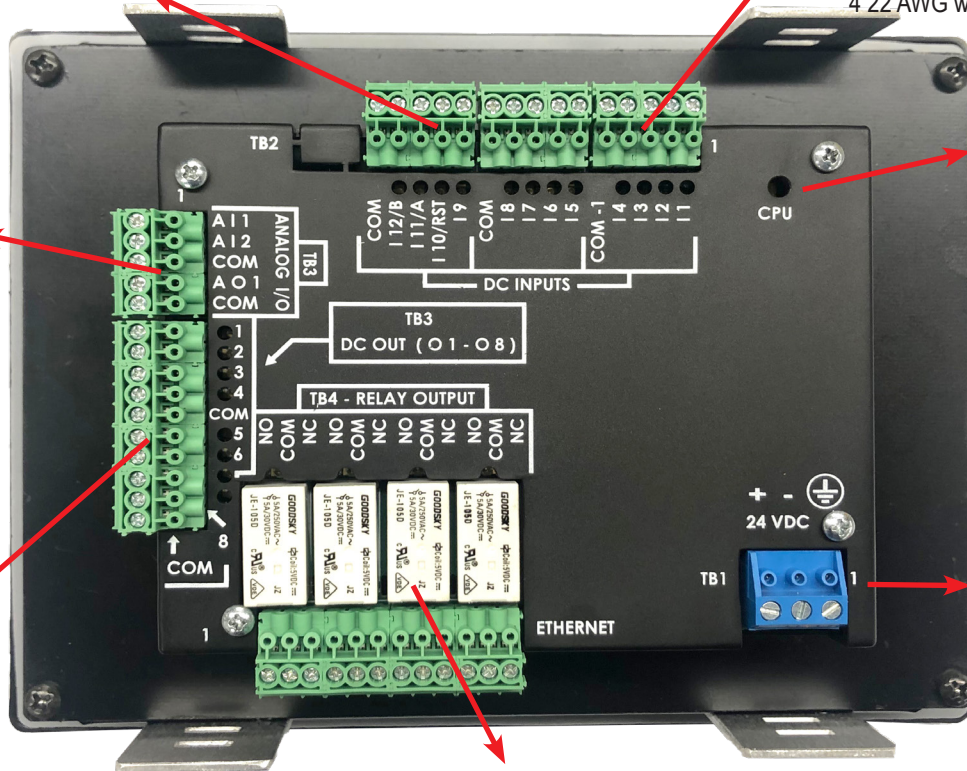

CPU LED indicator
powers ON when communication to HMI and Status indicator

24 VDC power input

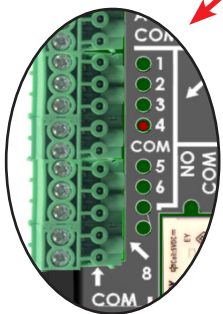

8 Digital Outputs, with LED indicators

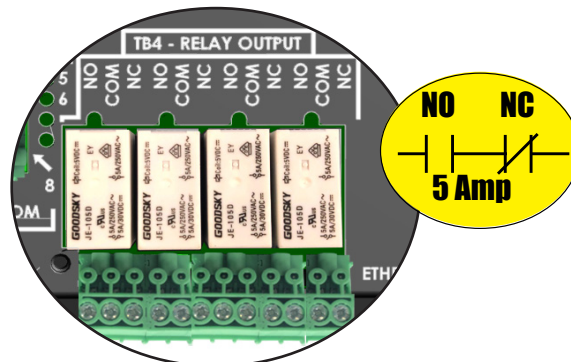

4 Relay (1 form C 5 Amp) Output
Used to drive output devices up to 5 Amps

